

Data Sheet



Article number: 20253018

Description: E+G Clamping pad
GN 709.2-18-B

Measures

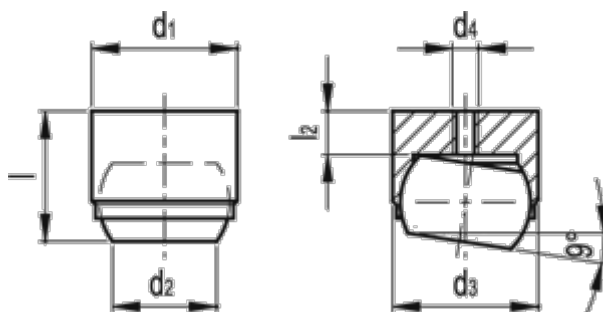

d1 m6 = 18
d2 = 10.5
d3 = 16
d4 = M4
d5 = 18
h min = 8
l +/-0.02 = 17
l2 = 4.0

Max static load (KN) = 25
Weight (g) = 30